

## UNIT - V

# ELECTRICITY

### Electric circuits

1. Electricity means the flow of electric current.
2. An electric circuit is a complete path through which electricity travels.
3. Circuits are made up of wires and electrical parts such as batteries, light bulbs, resistors, motors and switches.
4. A circuit diagram is a shorthand method of describing a working circuit.
5. A circuit diagram uses symbols to show the parts that a circuit is made up of.

### Open and closed circuits

**Closed circuit**

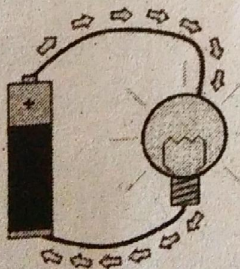

**Open circuit**

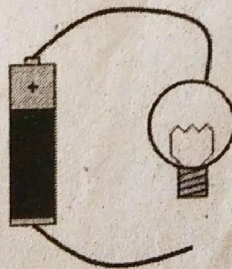

1. It is necessary to be able to turn on and off electrical circuits.
2. Electric current can only flow if there is a complete and unbroken path. This is called a closed circuit.

3. If a switch is opened or disconnecting a wire will cause the current to stop flowing this is called an open circuit.
4. Switches are used to turn electricity on and off.
5. Flipping the switch to off will cause an open circuit by making a break in the wire.

## Types of switches

### Manual switches

We have seen how relays and transistors can act as electronic switches. You can also have manual switches, which are activated by a user. Using a manual switch is a safe way for a person to interrupt the electron flow in a circuit without touching the wire. Switches allow you to turn current flow on and off in circuits. Switches are used in all electronic appliances, e.g., lights, computers, electric tools, televisions.

### Mechanical switches

Types of mechanical switches, each activated differently include.

1. Rocker switches
2. Push switches
3. Toggle switches
4. Slide switches
5. Limit switch/microswitch

### Rocker switch

An ordinary light switch is a rocker switch. It has two positions – on or off.

### Push switches

This is a switch you push to activate.

### Toggle switches

In a toggles switch the toggle (handle) moves or swings to make or break the circuit.

### Slide switches

In a slide switch a slider moves linearly (slides) from position to position.

### Limit switch/microswitch

A microswitch is used to limit something. It has a lever coming out of it that is easily pressed, e.g., by a gate opening or by a closed lid touching it.

### Electrical switches

Inside each of these mechanical switches is one or more electrical switch. Each electrical switch is made up of a pole and one or more throws.

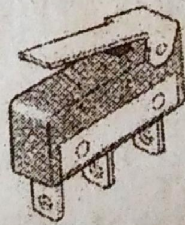
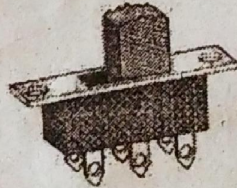
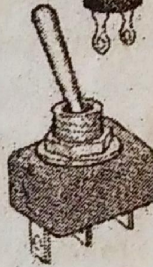

When the no: of circuits is controlled by a switch.

1. **Pole** : A moving wire in a switch that can move to a fixed wire to make a closed circuit or away from the fixed wire to make an open circuit.

2. **Throw** : A fixed wire stopping point inside a switch. *the no: of position that the switch can adopt*

When you close a switch, you are moving a pole to touch a throw. Electricity can flow through the metal which joins the pole to the throw, as metal conducts electricity. When you open a switch, electricity cannot travel across the air, as air is an insulator.

### Types of electrical switches

The number of poles and throws a switch has and how the poles move to touch the throws determines what type of switch it is.

Types of switches include.

- 1. Push to break
- 2. Push to make
- 3. SPST
- 4. SPDT
- 5. DPST
- 6. DPDT
- 7. DPDTCO

#### Push to break switch

Current flows normally, but not when the button is pushed.

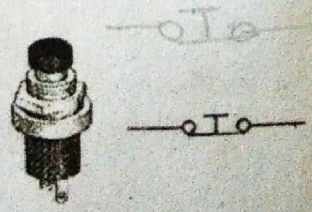

**SPST switch**

SPST (Single Pole Single Throw) switches are used for on/off operations and have only one switch and one way to make a connection, e.g., a light in a bedroom. SPST switch : One and one throw.

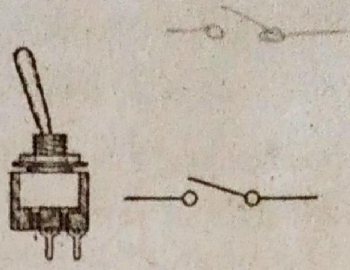

**SPDT switch**

SPDT (Single Pole Double Throw) switches are used for on/off operations but have two switches and two ways to make a connection, e.g., a light in a hall that can be switched on and off from the hall or the landing. SPDT switch : One pole with two throws.

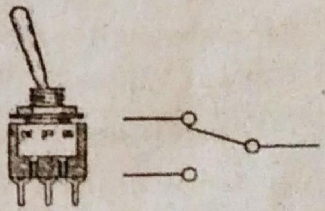

**DPST switch**

A DPST (Double Pole Single Throw) switch is a pair of SPST switches that operate together. Both are open or closed at the same time. DPST switch : Two poles, each with a single throw.

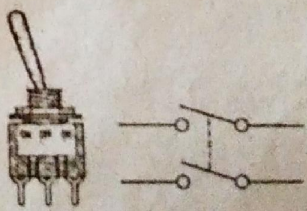

**DPDT switch**

A DPDT (Double Pole Double Throw) switch is a pair of SPDT

switches that operate together. Switching the DPDT switch controls two circuits. It is usually used to change the speed or direction of a motor. For example, when you switch on a hairdryer (with one mechanical switch), two electrical switches are activated inside one to turn on the fan and one to turn on the heat. DPDT switch : Two poles, each with two throws.

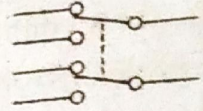

### Different types of fuses

A brief idea of the different types of fuses and their working is given here. The main components of a standard fuse unit consist of the items: Metal fuse element, Set of contacts, Support body. The major two categories of fuses included are (1) Low Voltage Fuses, (2) High Voltage Fuses. In order to understand Low voltage fuses better, and can further classified into: Semi Enclosed or Rewireable Type, Totally enclosed or Cartridge Type.

### Rewireable Fuses

This kind of fuse is most commonly used in the case of domestic wiring and small scale usage. Another name for this type is the Kit-Kat type fuse. The main composition is of a porcelain base which holds the wires. The fuse element is located inside a carrier that is also made out of porcelain. It is possible to remove the fuse carrier without any risk of electrical shock. Normally what happens is that when the fuse blows, it can be replaced without having to

change the complete thing. The main metals or alloys used in making fuse wire include lead, tinned copper, aluminum or tin lead alloy. When there is an over surge that causes the fuse element to blow off, it can be replaced. A new fuse carrier is inserted in the base. The main advantage of this type of fuse is that it is easy to install and also replace without risking any electrical injury. Totally Enclosed or Cartridge Type In this type of fuse has a completely closed container and there are contacts (metal) on either side. The level of sub division in this case includes, D type, Link Type.

### **D Type Cartridge Fuses**

This cannot be interchanged and comes with the following main components: fuse base and cap, adapter ring and the cartridge. The fuse base has the cap screwed to it and the cartridge is pushed into it. The circuit becomes complete when the tip of the cartridge is in contact with the conductor. In this case, the main advantage is that of reliability.

### **Link Type Cartridge fuses**

In Link type, further a knife blade type and bolted types are available. The Knife Blade Type HRC Fuse is easily replaceable in the circuit without any load. For this purpose, special insulated fuse pullers are used. In the Bolted Type HRC Link Fuse, the conducting plates are bolted to the base of the fuse. There is also a presence of a switch through which the fuse can be removed without getting an electrical shock.

In HRC fuse or High Rupturing Capacity Fuse, the fuse wire or element can carry short circuit heavy current for a known time period. During this time if the fault is removed, then it does not blow off otherwise it blows off or melts. The enclosure of HRC fuse is either of glass or some other chemical compound. This enclosure is fully air tight to avoid the effect of atmosphere on the fuse materials.

The ceramic enclosure having metal end cap at both heads, to which fusible silver wire is welded. The space within the enclosure, surrounding the fuse wire or fuse element is completely packed with a filling powder. This type of fuse is reliable and has inverse time characteristic, that means if the fault current is high then rupture time is less and if fault current is not so high then rupture time is long.

The Operation of HRC fuse clearly shows that when the over rated current flows through the fuse element of High Rupturing Capacity Fuse the element is melted and vaporized. The filling powder is of such a quantity that the chemical reaction between the silver vapor and the filling powder forms a high resistance substance which very much helps in quenching the arc.

### \* **Device circuit breakers**





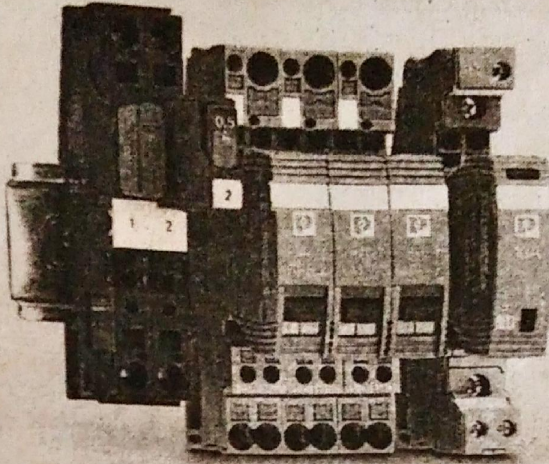

The requirements for optimum device protection vary depending on the area of application and tasks. For this reason, various device circuit breakers that work with different technologies have been developed over time. There are electronic, thermo-magnetic and



thermal device circuit breakers. The differences lie in the tripping technologies and shutdown behavior. Characteristics curves clearly illustrate the shutdown characteristics of the various device circuit breakers.



### Selection criteria

	Tripping time in the case of overload	Tripping time in the event of a short circuit	Your application is optimally protected for
<b>Thermal circuit breakers</b>			<ul style="list-style-type: none"> <li>• Overload</li> </ul>
<b>Thermo-magnetic circuit breakers</b>			<ul style="list-style-type: none"> <li>• Overload</li> <li>• Short circuit</li> <li>• Long cable paths (SFB tripping characteristic)</li> </ul>
<b>Electronic circuit breakers</b>			<ul style="list-style-type: none"> <li>• Overload</li> <li>• Short circuit</li> <li>• Long cable paths (active current limitation)</li> </ul>

Device circuit breakers are selected based on the nominal voltage, nominal current and if required the starting current of a terminal device. In addition, the shutdown behavior of the device circuit breaker must correspond to the expected error situations. There are differences in error situations involving a short circuit and those involving an overload.

### Carey Foster Bridge

A Carey Foster Bridge is principally the same as a metre bridge except that two more gaps are provided as shown in figure. This bridge is used to measure the difference between two nearly equal resistances and knowing the value of one, the other can be calculated. In this bridge, the end resistances are eliminated in calculations, which is an advantage and hence it can conveniently be used to measure a given low resistance.

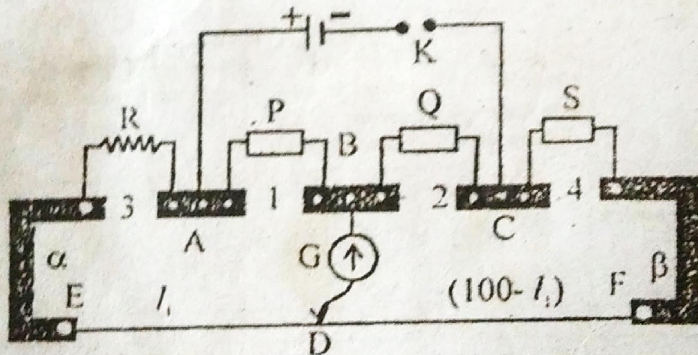

P and Q are two resistance boxes connected in the inner gaps 1 and 2, R is the unknown low resistance and S is a fractional resistance box. Let the length of the bridge wire be 100 cm and  $l_1$  and  $P$  the end resistances on the sides of R and S respectively. The galvanometer G is connected between the points B and D. The cell is connected through a key between the points A and C.

Keeping suitable values of P and Q, the resistance R is placed in the left gap and S in the right gap and the balance length  $l_1$  is measured from the point E. R and S are interchanged and the balancing length  $l_2$  is noted. The experiment is repeated for different values of known resistances. Fig. a and b represent the equivalent Wheatstone's bridge circuit in the two cases. Let  $\rho$  be the resistance per unit length of the bridge wire.

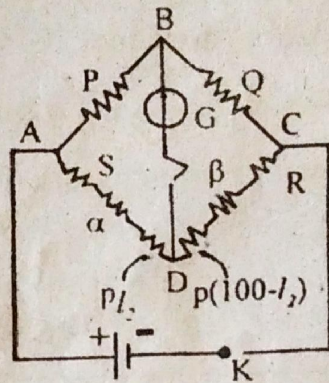
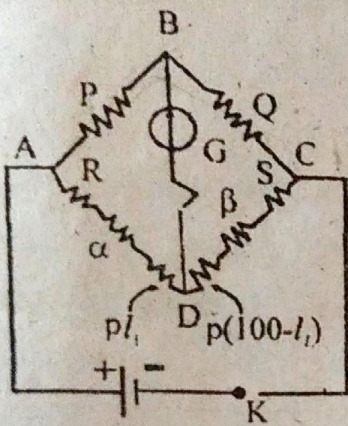

For zero deflection of the galvanometer, in the first case

$$\frac{P}{Q} = \frac{R + \alpha + l_1 \rho}{S + \beta + (100 - l_1) \rho} \quad \text{--- (i)}$$

In the second case

$$\frac{P}{Q} = \frac{S + \alpha + l_2 \rho}{R + \beta + (100 - l_2) \rho} \quad \text{--- (ii)}$$

Equating the right hand sides of (i) and (ii)

$$\frac{R + \alpha + l_1 \rho}{S + \beta + (100 - l_1) \rho} = \frac{S + \alpha + l_2 \rho}{R + \beta + (100 - l_2) \rho}$$

Adding one to both sides

$$\frac{R + \alpha + l_1 \rho + S + \beta + 100 - l_1 \rho}{S + \beta + (100 - l_1) \rho} = \frac{S + \alpha + l_2 \rho + R + \beta + 100 \rho - l_2 \rho}{R + \beta + (100 - l_2) \rho}$$

$$\frac{R + S + \alpha + \beta + 100 \rho}{S + \beta + (100 - l_1) \rho} = \frac{R + S + \alpha + \beta + 100 \rho}{R + \beta + (100 - l_2) \rho} \quad \text{--- (iii)}$$

The numerators of equation (iii) are equal. Therefore, the denominators are equal

$$S + \beta + 100 \rho - l_1 \rho = R + \beta + 100 \rho - l_2 \rho$$

$$\text{Or} \quad S - l_1 \rho = R - l_2 \rho$$

$$\text{Or} \quad R - S = S + \rho (l_2 - l_1) \quad \text{--- (iv)}$$

$$\text{Or} \quad R = S + \rho (l_2 - l_1) \quad \text{--- (v)}$$

Thus, knowing the values of  $l_1$  and  $l_2$ , the difference  $R - S$  can be calculated, provided  $\rho$  be resistance per unit length of the bridge wire is known (equation iv). Further, if the value of  $S$  is known,  $R$  can be calculated (equation v).

### (ii) Determination of $\rho$

To determine the resistance per unit length of the bridge wire, the resistance  $R$  is replaced by a thick copper strip (i.e.,  $R = 0$ ) and the balancing length  $l_1'$  is determined. Now keeping  $S$  in the left gap and the copper strip in the right gap the balancing length  $l_2'$  is determined with the same values of  $P$  and  $Q$ .

From equation (v)

$$0 = S + \rho(l_2' - l_1')$$

$$\text{Or } \rho = \frac{S}{(l_2' - l_1')} \quad \text{--- (vi)}$$

The experiment is repeated with different values of  $S$  and the mean value of  $\rho$  is taken.

## Potentiometer

### Principle

A potentiometer is a device for measuring or comparing potential differences. A potentiometer can be used to measure any electrical quantity which can be converted into a proportionate D.C potential difference.

It consists of a uniform wire AB of length 10m stretched on a wooden board (figure). A steady current is passed through the wire AB with the help of a cell of EMF  $E$ . Let

$\rho$  = resistance per unit length of potentiometer wire

$I$  = steady current passing through the wire.

Let  $C$  be a variable point.

Let  $AB = L$  and  $AC = l$

PD across  $AB = L\rho I$ ,

and

PD across  $AC = l\rho I$

$$\frac{\text{PD across AB}}{\text{PD across AC}} = \frac{L\rho l}{l\rho l} = \frac{L}{l}$$

$$\text{PD across AC} = (l/L) \times \text{PD across AB}$$

i.e., for a steady current passing through the potentiometer wire A the PD across any length is proportional to the length of the wire.

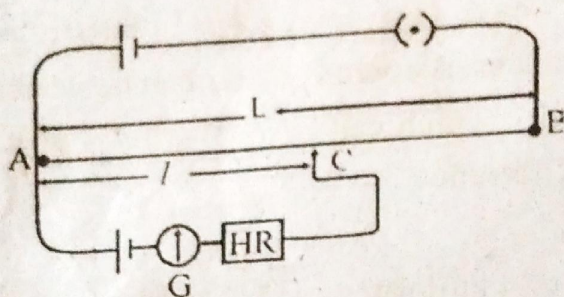

If a D.C voltmeter is connected between A and the variable point C it will be noted that the voltmeter registers greater values of PD's as the point C slides from A to B.

### Calibration of Ammeter

Connect the ends of the potentiometer wire to the terminals of a storage cell through a key  $K_1$  (figure) S is a standard cell. Connect the ammeter (A) to be calibrated in series with a battery, key  $K_2$ , a rheostat and a standard resistance R. When a current I passes through the standard resistance R the PD across R is IR. This potential drop is measured with the help of potentiometer.

Connect 1 and 3 and balance the EMF of the standard cell against the potentiometer. Find the balancing length ( $l$ ) from A. The PD per cm of the potentiometer =  $E/l$ .

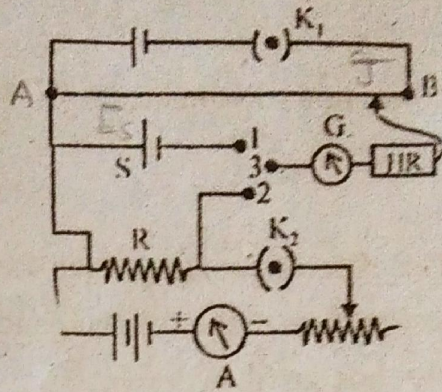

Connect 2 and 3. Adjust the rheostat so that the ammeter reads a value  $A_1$ . Balance the PD across R against the potentiometer and find the balancing length  $l_1$ .

$$\text{PD Cross R} = El_1/l$$

$$\text{Current through R} = El_1/(IR)$$

$$\text{Correction to ammeter reading} = R_1 = (El_1/IR) - A_1$$

Similarly, the corrections for other ammeter readings are determined. A calibration curve is plotted for ammeter, taking ammeter reading of X-axis and correction on Y-axis.

### Calibration of voltmeter (Low range)

The connections are made as shown in figure. The voltmeter is connected parallel to R. Let  $l$  be the balancing length for the standard cell. The PD across R is balanced against the potentiometer. Let  $l_1$  be the balancing length when the voltmeter reads  $V_1$ .

$$\text{PD across } R = EI_1/l$$

$$\text{Correction to voltmeter} = (EI_1/l) - V_1$$

The experiment is repeated for various readings of the voltmeter and a calibration graph is drawn.

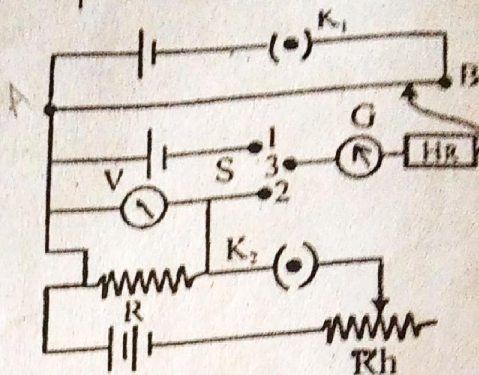

### University Questions

#### 2 Mark questions

1. Draw the diagram of Carey Foster Bridge and write equation for unknown resistance.
2. Write principle of potentiometer.
3. How you can calibrate potentiometer as a ammeter.
4. What are types of mechanical switches?
5. What is Rewireable fuse?
6. What are device circuit breakers?

#### 5 Mark questions

1. Derive equation for un known resistance using Carey - Foster bridge.
2. Explain potentia meter with using circuit diagrams.